



ARVABIL DREAM INCEPTION

PRODUCT & DESIGN

swing

design and development

*When you are on a down
swing, do not feel bad. Know
the swing will change and
things will get better. There
are good times coming*

www.arvabilproduct.com



ABOUT US

Arvabil Dream Inception was established in 2015. We are Designer, Developer, manufacturer trader and exporter of Organic design Products, Hand made and Agriculture Related Products. We are also offering a vast collection of Furniture Products, which are available in different modern designs and stylish patterns. Our products are well tested on well defined parameters.

We specialize in one thing....beautiful natural organic decorating. Whether you enjoy surrounding yourself with time honored traditional design, or inspired, modern, cutting edge couture it's our ultimate goal to design spaces that reflect your taste and your lifestyle. Our first and foremost aim is customer satisfaction. We at 'Arvabil Dream inception" have thousands of samples of top quality products we also pay attention to the functionality which makes our products and designs unique.

Rect Hang Swing

Code - ADI666RH-SW

Application

Garden, Patio, Restaurant, Hotel, Beach, Resort and all the other leisure places.

Characteristic

UV-resistant, color-fast, waterproof, anti-mildew, comfortable, long-lasting, durable.

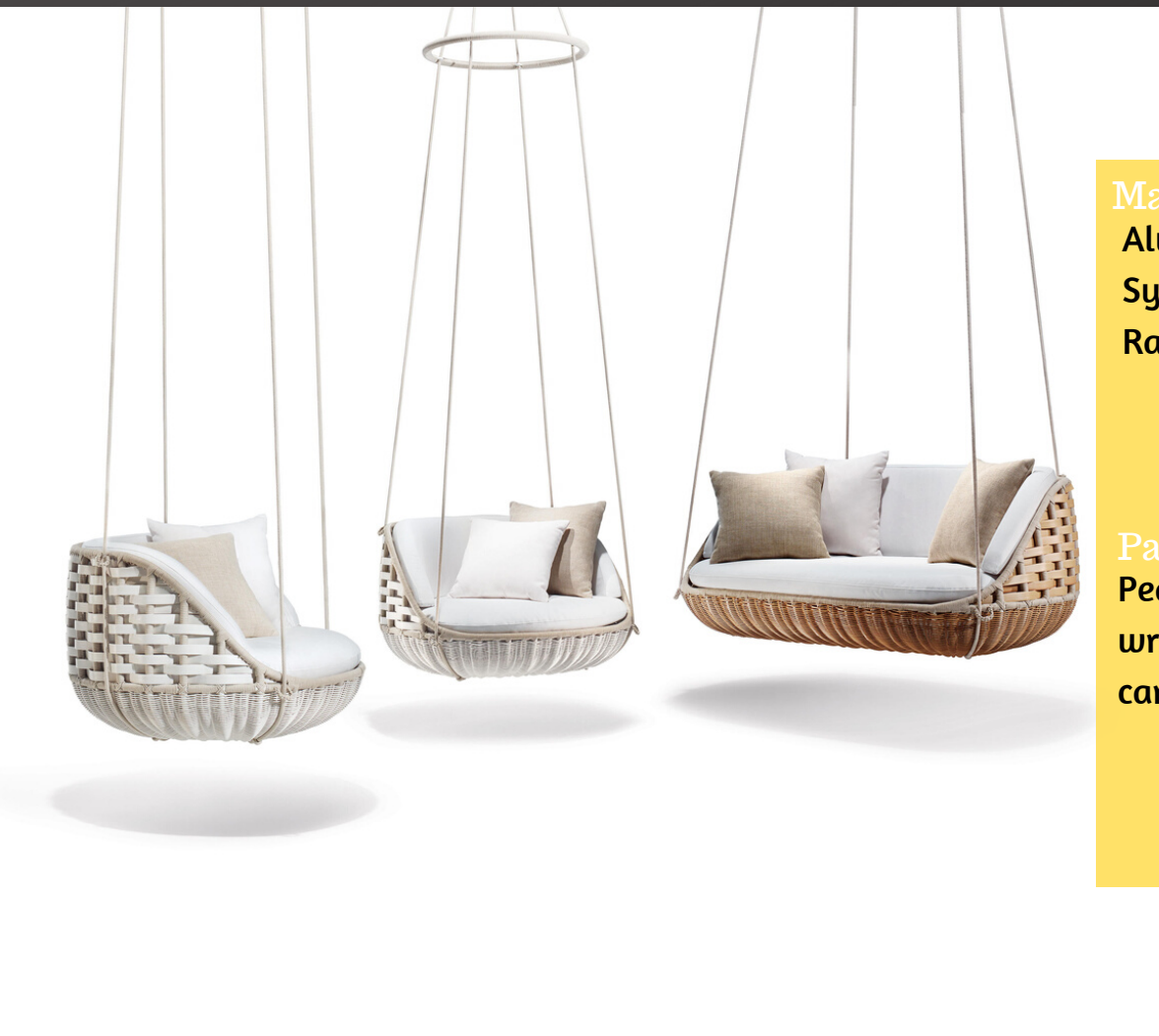

Material

Aluminum or iron frame,
Synthetic fiber, Rope
Rattan, Wicker

Packaging:

Pearl foam inside, Bubble wrap and Kraft paper or carton outside.



Color
Natural, White

Size
1 Seater - 89 x 81 cm
2 Seater - 133 x 81 cm

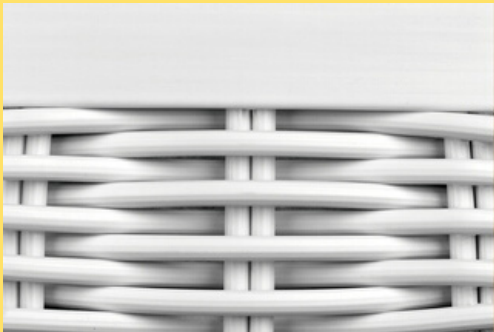
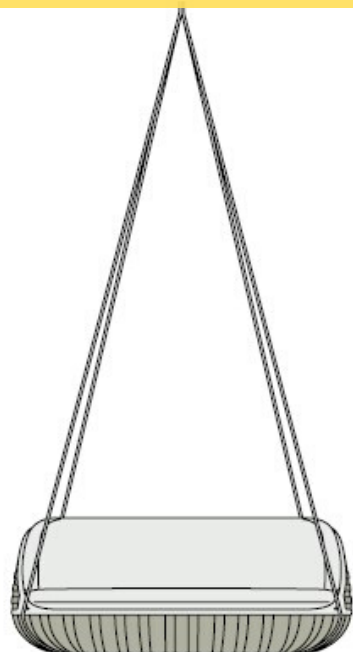
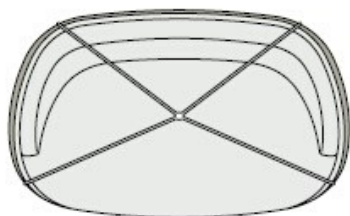
133
52¼

17 8
6¾ 3¼

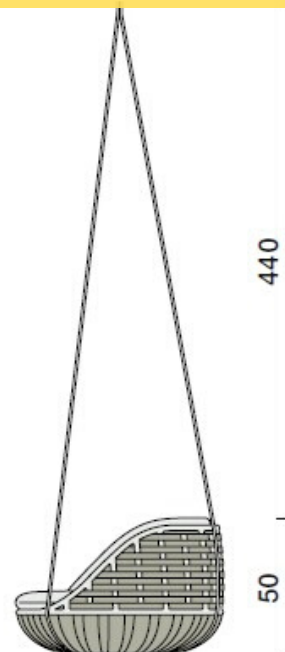

81
32

440
173
50
19¾

cm
inch

Round Hang Swing

Code - ADI666RD-SW

Application

Garden, Patio, Restaurant, Hotel, Beach, Resort and all the other leisure places.

Characteristic

UV-resistant, color-fast, waterproof, anti-mildew, comfortable, long-lasting, durable.



Material

Aluminum or iron frame,
Synthetic fiber, Rope
Rattan, Wicker



Packaging:

Pearl foam inside, Bubble wrap and Kraft paper or carton outside.



Color
Natural, White

Size
196 x 193 cm

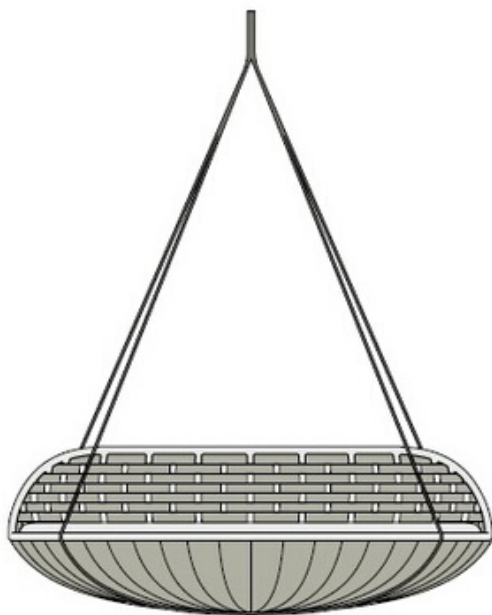
193
76

32 4
12 1/2 1 1/2

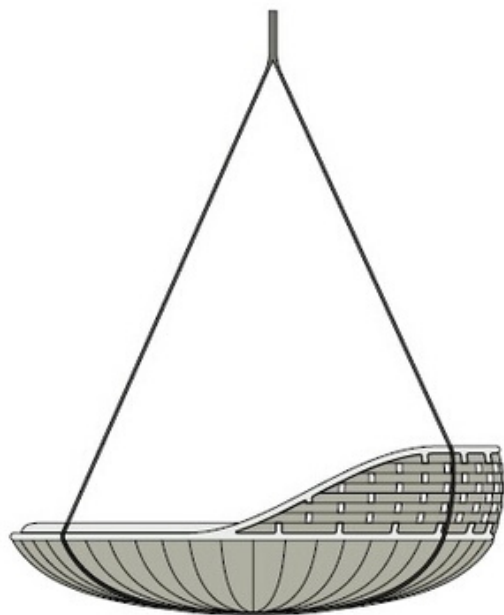

196
77 1/4

67
26 1/2

Nest-Rest Swing

Code - ADI666NR-SW

Application

Garden, Patio, Restaurant, Hotel, Beach, Resort and all the other leisure places.

Characteristic

UV-resistant, color-fast, waterproof, anti-mildew, comfortable, long-lasting, durable.



Material

Aluminum or iron frame,
Synthetic fiber, Rope
Rattan, Wicker



Packaging:

Pearl foam inside, Bubble wrap and Kraft paper or carton outside.



Color
Natural, White

Size
Ø 200cm

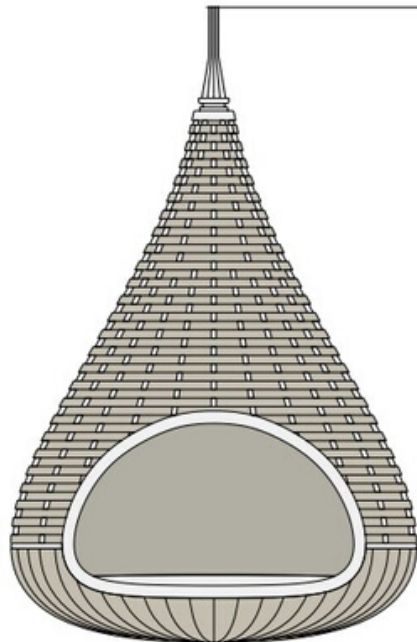
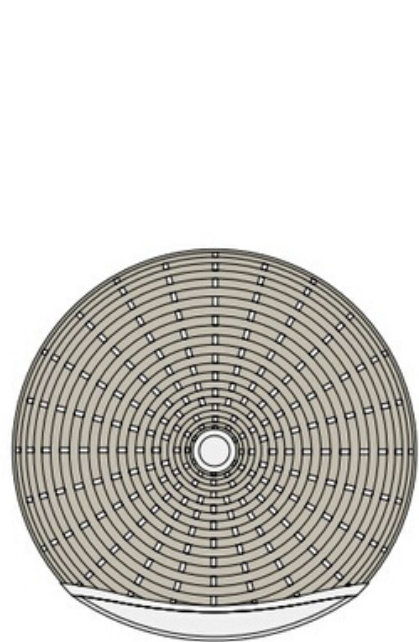
130
51¼

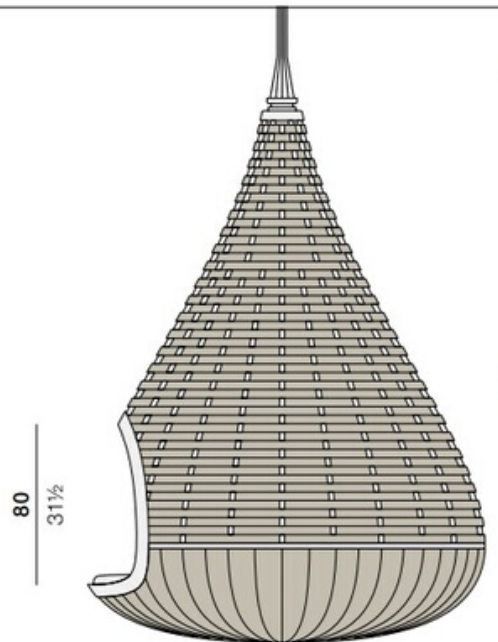

80
31½

Ø 200
Ø 78¼

100
39¼

268
105½

Natural Basket Swing

Code - ADI666NB-SW

Application

Garden, Patio, Restaurant, Hotel, Beach, Resort and all the other leisure places.

Characteristic

UV-resistant, color-fast, waterproof, anti-mildew, comfortable, long-lasting, durable.



Material

Aluminum or iron frame,
Synthetic fiber,
Rattan, Wicker

Packaging:

Pearl foam inside, Bubble wrap and Kraft paper or carton outside.



Color
Natural, White

Size
70cm (H) x 110cm (W) x 110cm (D)

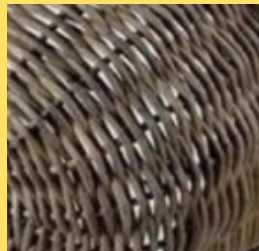

Natural Egg Swing

Code - ADI666NEG-SW

Application

Garden, Patio, Restaurant, Hotel, Beach, Resort and all the other leisure places.

Characteristic

UV-resistant, color-fast, waterproof, anti-mildew, comfortable, long-lasting, durable.



Material

Aluminum or iron frame,
Synthetic fiber,
Rattan, Wicker

Packaging:

Pearl foam inside, Bubble wrap and Kraft paper or carton outside.



Color
Natural, Black

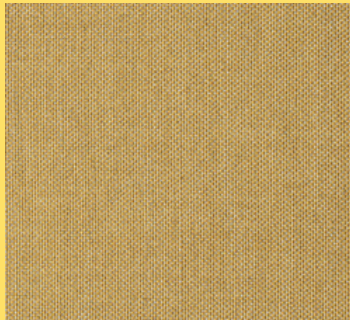

Size
125cm (H) x 85cm (W) x 75cm (D)

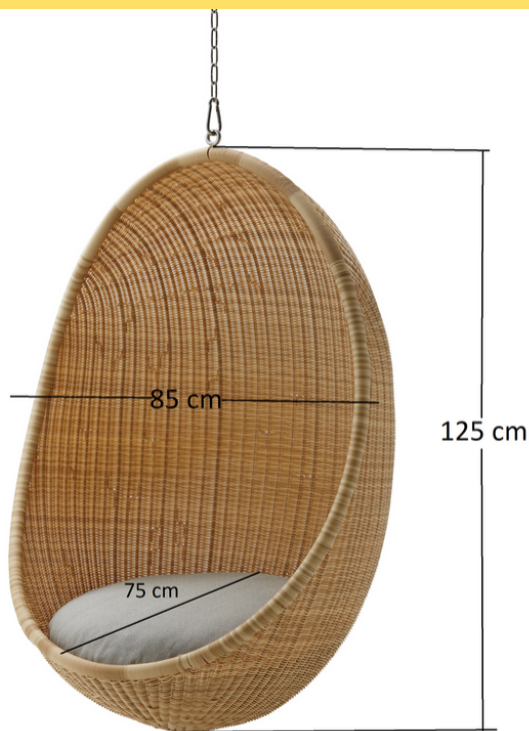

Nest Egg Swing

Code - ADI666NE-SW

Application

Garden, Patio, Restaurant, Hotel, Beach, Resort and all the other leisure places.

Characteristic

UV-resistant, color-fast, waterproof, anti-mildew, comfortable, long-lasting, durable.

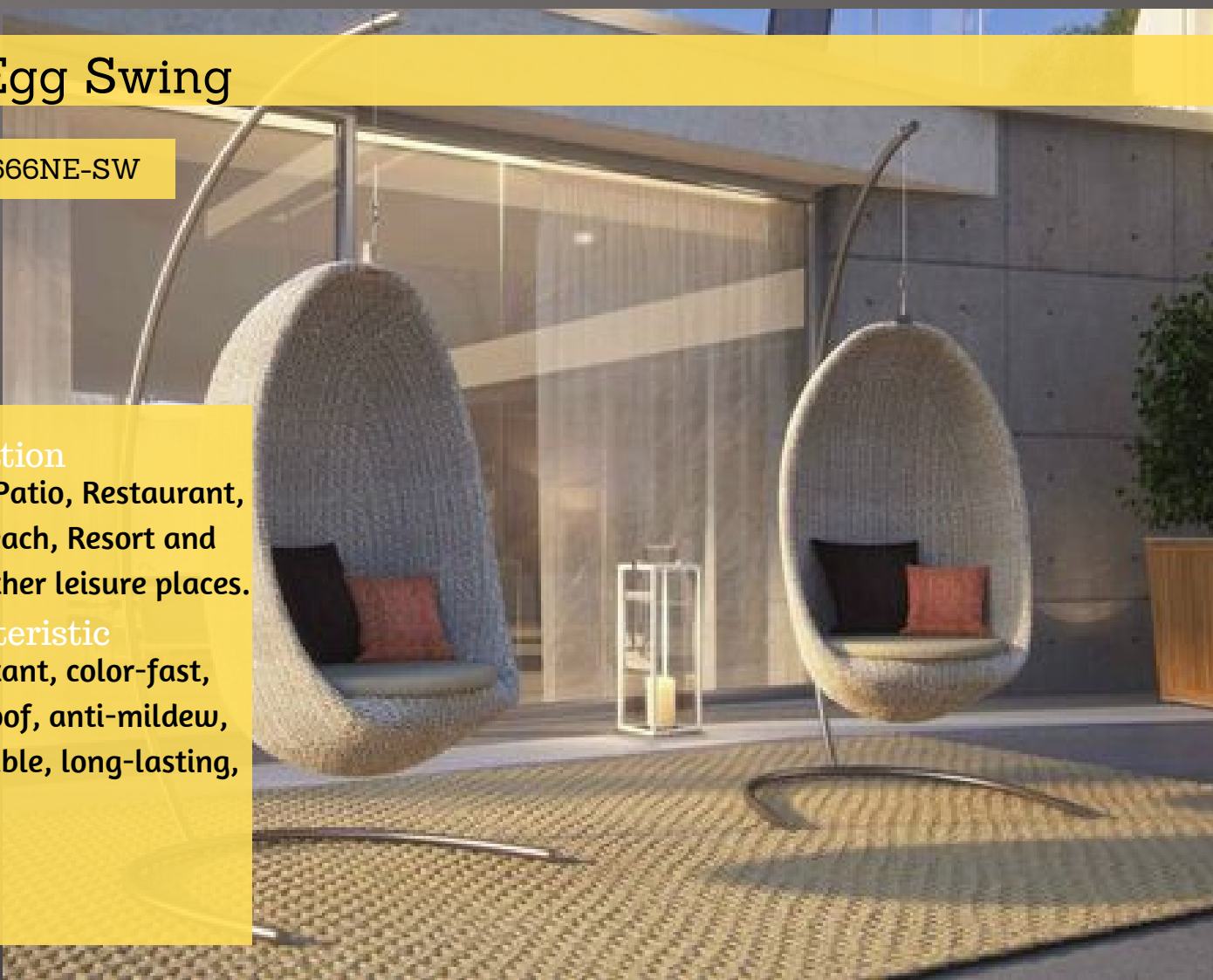

Material

Aluminum or iron frame,
Synthetic fiber,
Rattan, Wicker

Packaging:

Pearl foam inside, Bubble wrap and Kraft paper or carton outside.



Color
Colonial and Java

Size
130cm (H) x 85cm (W) x 66cm (D)

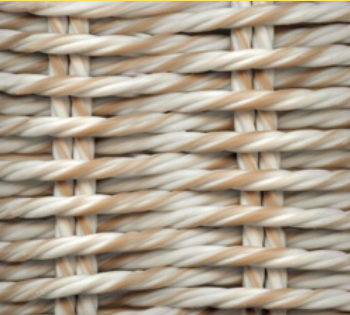

Round Nest Egg Swing

Code - ADI666RNE-SW

Application

Garden, Patio, Restaurant, Hotel, Beach, Resort and all the other leisure places.

Characteristic

UV-resistant, color-fast, waterproof, anti-mildew, comfortable, long-lasting, durable.



Material

Aluminum or iron frame,
Synthetic fiber,
Rattan, Wicker

Packaging:

Pearl foam inside, Bubble wrap and Kraft paper or carton outside.

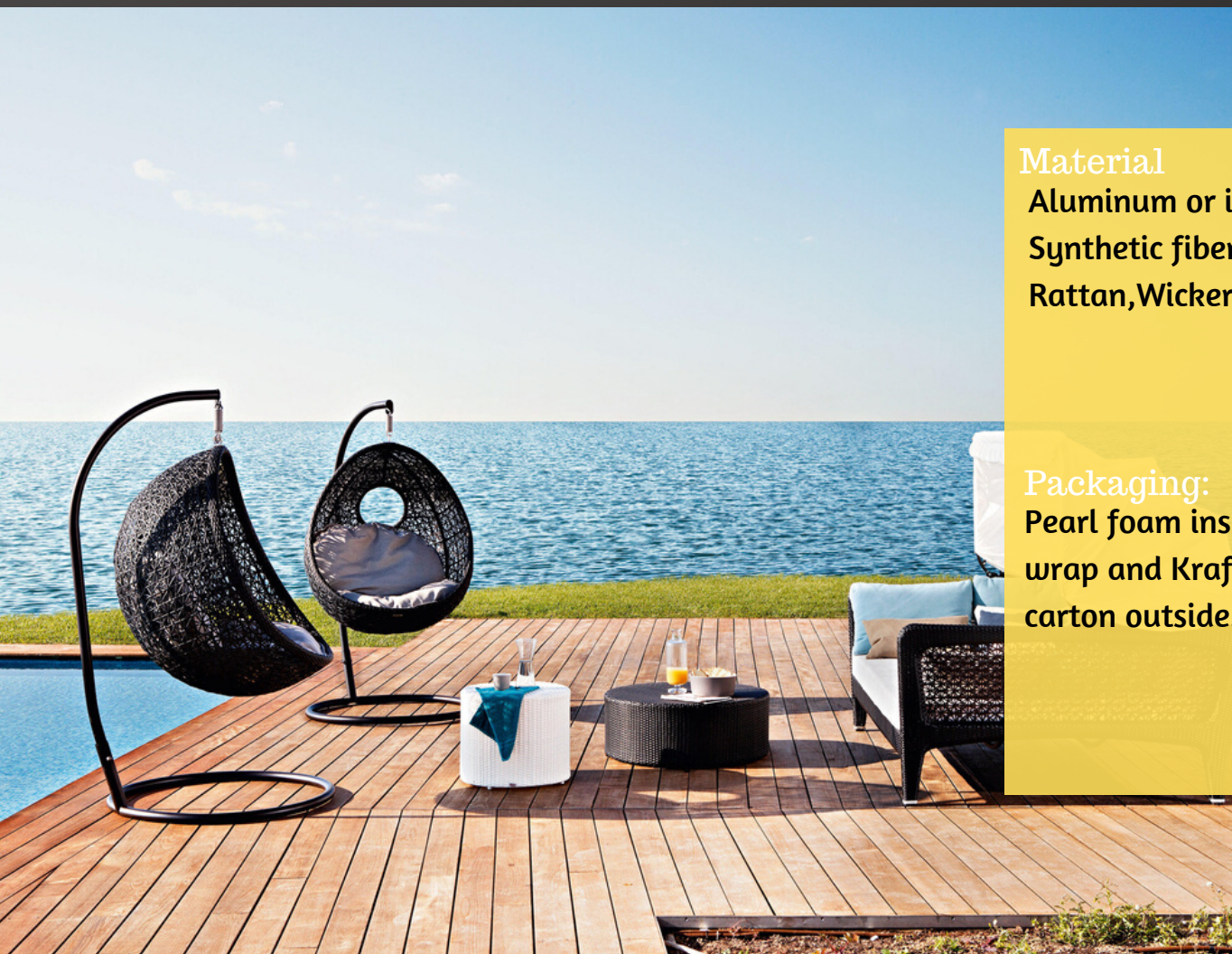



Color
Black and White

Size
130cm (H) x 85cm (W) x 66cm (D)

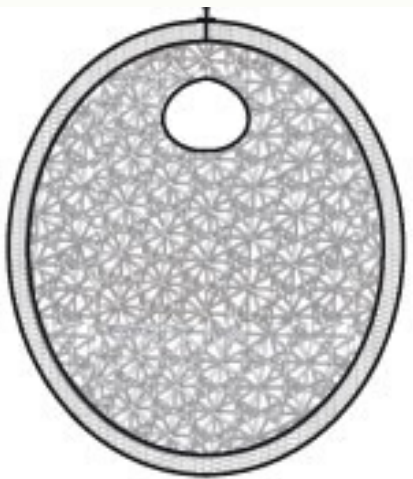
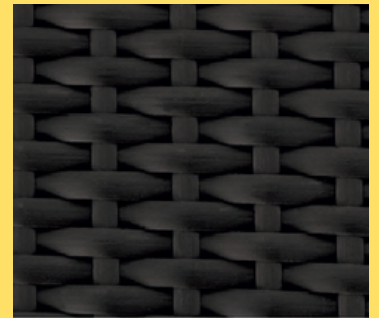
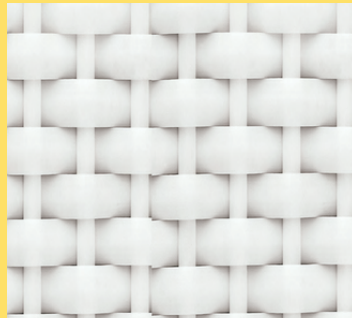

93

CM



110

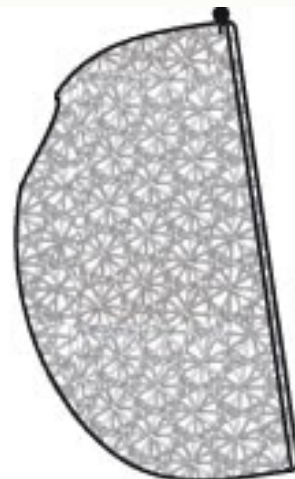

86

Jannat Egg Swing

Code - ADI666JEGG-SW

Application

Garden, Patio, Restaurant, Hotel, Beach, Resort and all the other leisure places.

Characteristic

UV-resistant, color-fast, waterproof, anti-mildew, comfortable, long-lasting, durable.



Material

Aluminum or iron frame,
Synthetic fiber,
Rattan, Wicker

Packaging:

Pearl foam inside, Bubble wrap and Kraft paper or carton outside.



Color
Black and White

Size
120cm (H) x 105cm (W) x 85cm (D)

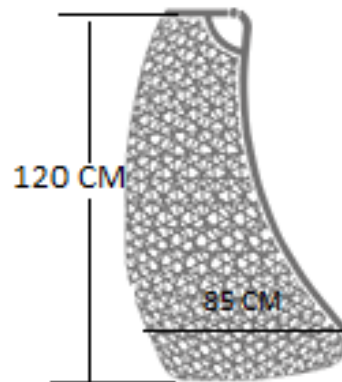
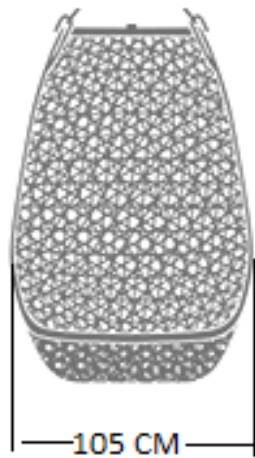

Jannat shadow Swing

Code - ADI666JSH-SW

Application

Garden, Patio, Restaurant, Hotel, Beach, Resort and all the other leisure places.

Characteristic

UV-resistant, color-fast, waterproof, anti-mildew, comfortable, long-lasting, durable.

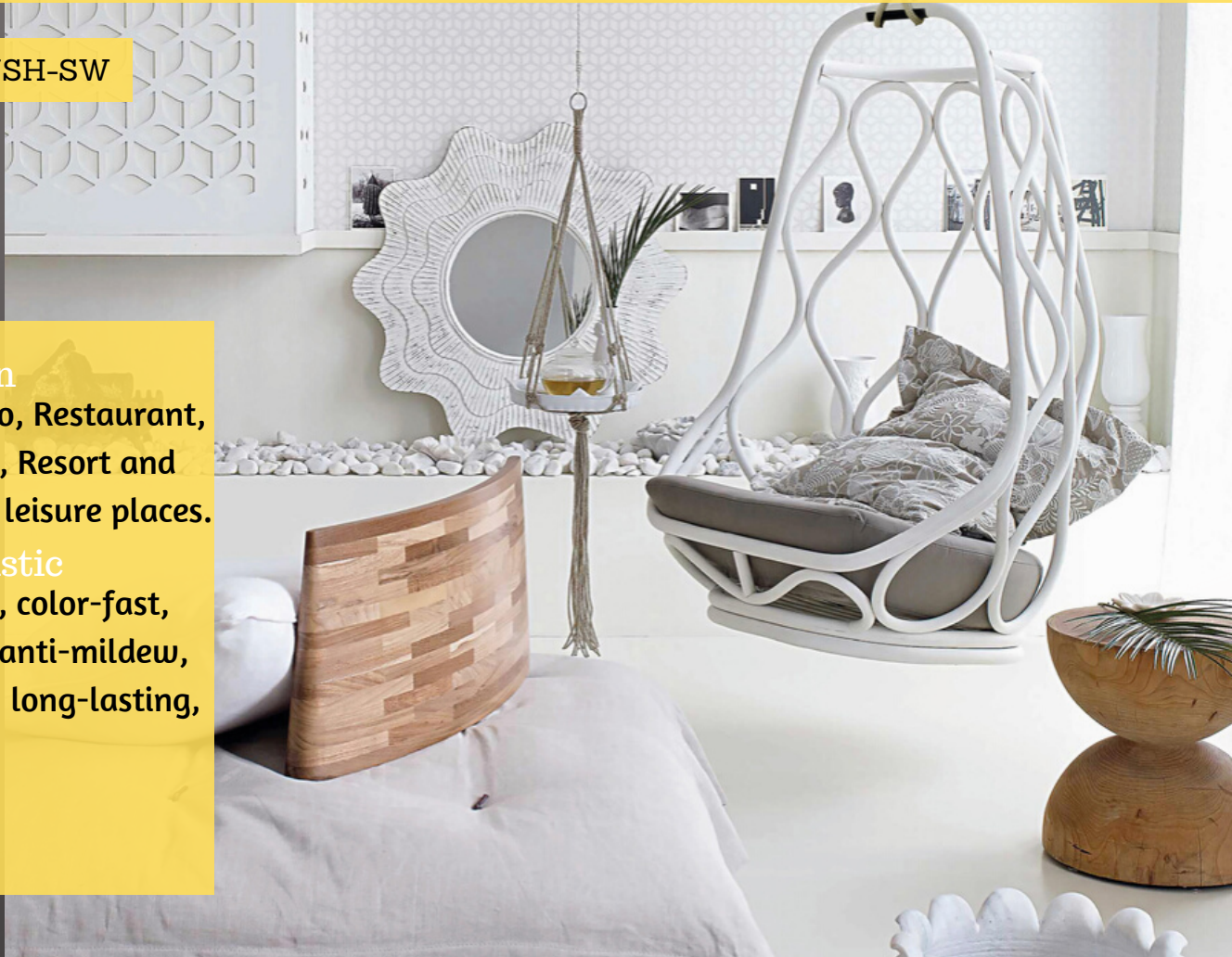

Material

Aluminum or iron frame, Synthetic fiber, Rattan, Wicker

Packaging:



Pearl foam inside, Bubble wrap and Kraft paper or carton outside.



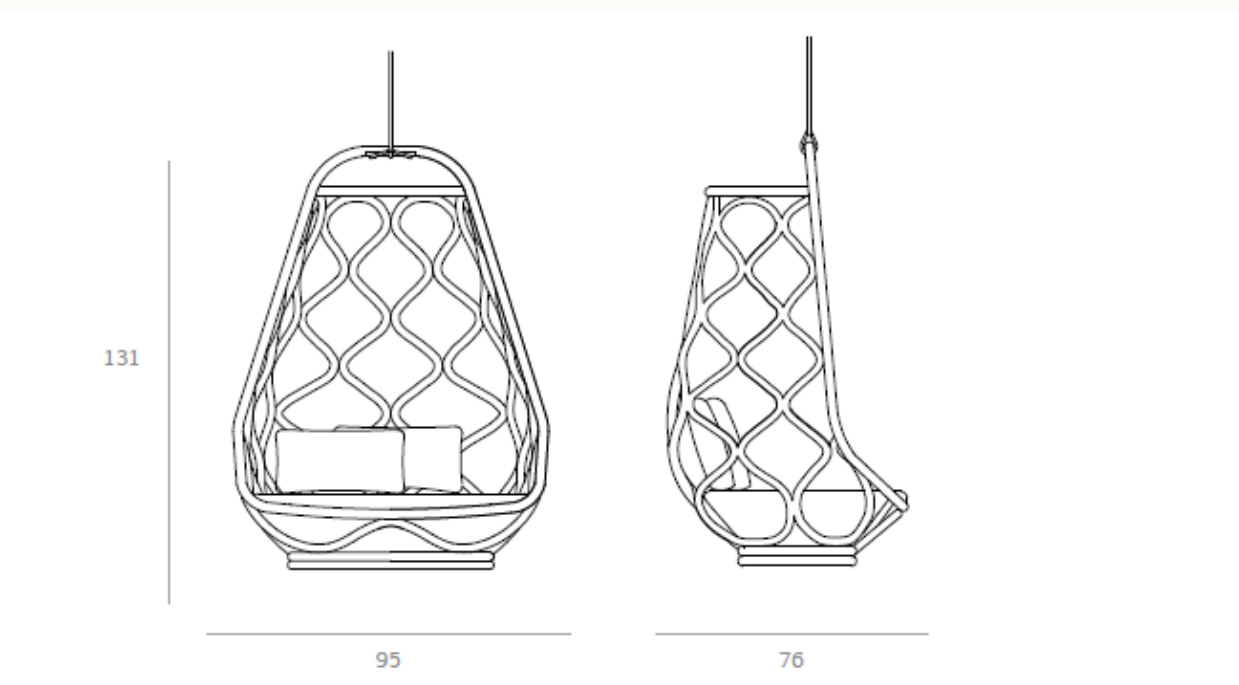

Color
Black, Red and White

Size
131cm (H) x 95cm (W) x 76cm (D)



Rainbow Ababil Swing

Code - ADI666RAS-SW

Application

Garden, Patio, Restaurant, Hotel, Beach, Resort and all the other leisure places.

Characteristic

UV-resistant, color-fast, waterproof, anti-mildew, comfortable, long-lasting, durable.



Material

stainless steel Frame,
polymer cord
Synthetic fiber,

Packaging:

Pearl foam inside, Bubble wrap and Kraft paper or carton outside.



Color
Multicolour, Natural

Size
101cm (H) x 106cm (W) x 84cm (D)

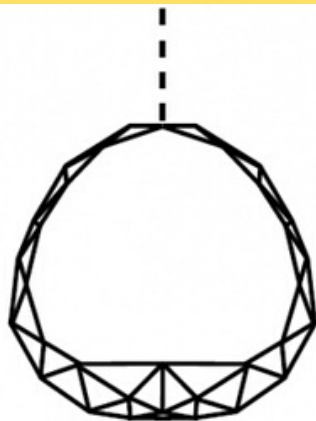
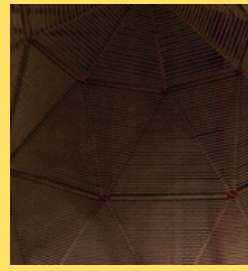
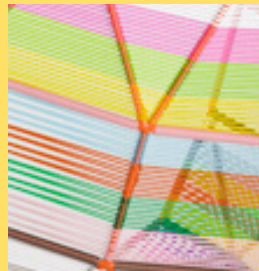

60 cm

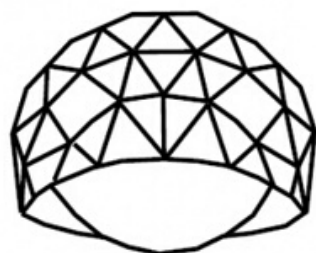

106 cm

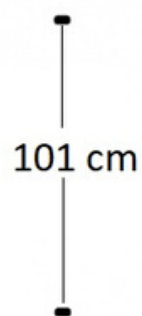

101 cm

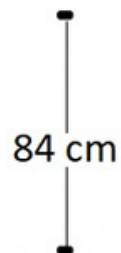

84 cm



Cocoon Hang Chair

Code - ADI666CHS-SW

Application

Garden, Patio, Restaurant, Hotel, Beach, Resort and all the other leisure places.

Characteristic

UV-resistant, color-fast, waterproof, anti-mildew, comfortable, long-lasting, durable.



Material

stainless steel Frame,
Lather, Synthetic Fiber

Packaging:

Pearl foam inside, Bubble wrap and Kraft paper or carton outside.





Color
Optional Custmize



Size
165cm (H) x 67cm (W) x 112cm (Ø)

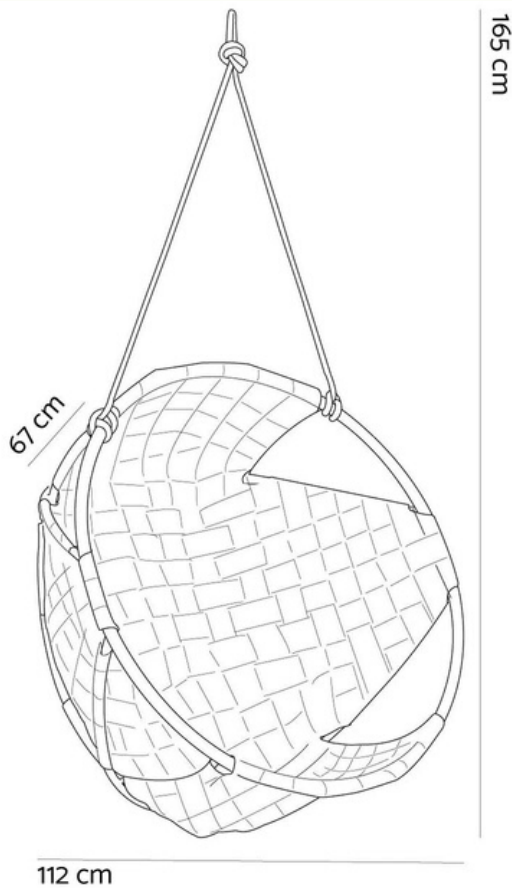

Gravity Shadow Swing

Code - ADI666GS-SW

Application

Garden, Patio, Restaurant, Hotel, Beach, Resort and all the other leisure places.

Characteristic

UV-resistant, color-fast, waterproof, anti-mildew, comfortable, long-lasting, durable.



Material

stainless steel Frame,
Nautical Rope, Synthetic
Fiber

Packaging:

Pearl foam inside, Bubble
wrap and Kraft paper or
carton outside.





Color
champagne

Size
238cm (H) x 133cm (Ø)

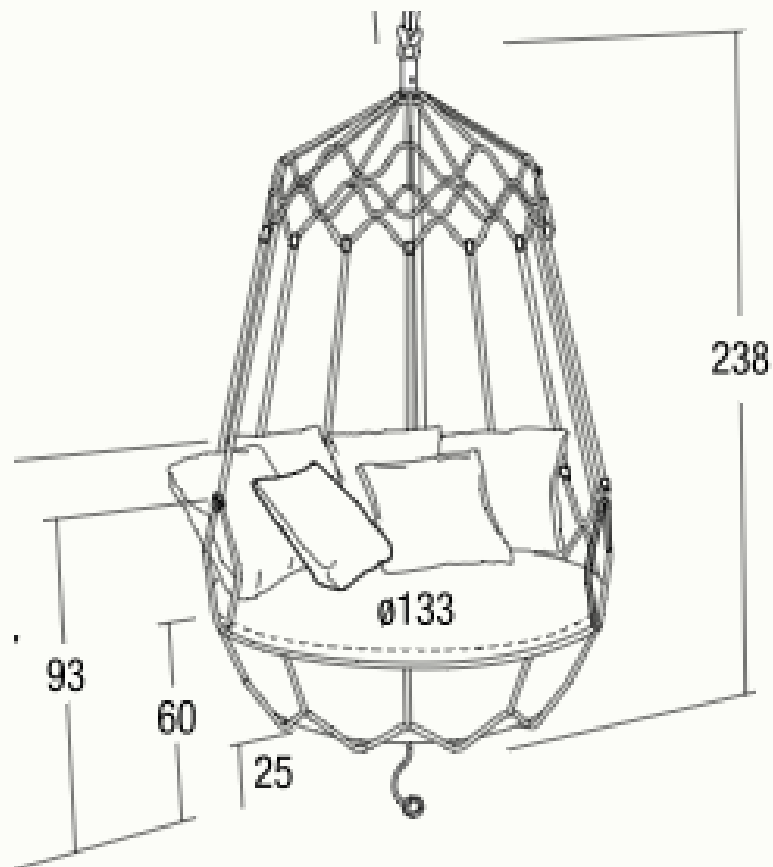

Hammock Hang Swing

Code - ADI666HK-SW

Application

Garden, Patio, Restaurant, Hotel, Beach, Resort and all the other leisure places.

Characteristic

UV-resistant, color-fast, waterproof, anti-mildew, comfortable, long-lasting, durable.



Material

Wood Frame, Cotton net

Packaging:

Pearl foam inside, Bubble wrap and Kraft paper or carton outside.



Color
Walnut, White

Size
140cm (H) x 135cm (W) x 431cm (L)

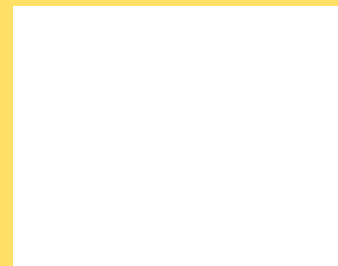

Altaf Bitta Swing

Code - ADI666AB-SW

Application

Garden, Patio, Restaurant, Hotel, Beach, Resort and all the other leisure places.

Characteristic

UV-resistant, color-fast, waterproof, anti-mildew, comfortable, long-lasting, durable.



Material

Aluminum or iron frame, Synthetic fiber, Rattan, Wicker

Packaging:

Pearl foam inside, Bubble wrap and Kraft paper or carton outside.



Color
Optional Customize

Size
82cm (H) x 89cm (W) x 175cm (L)

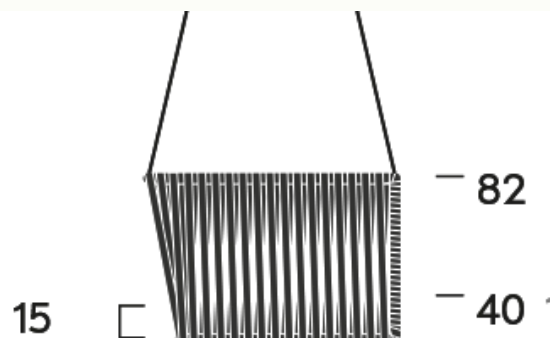
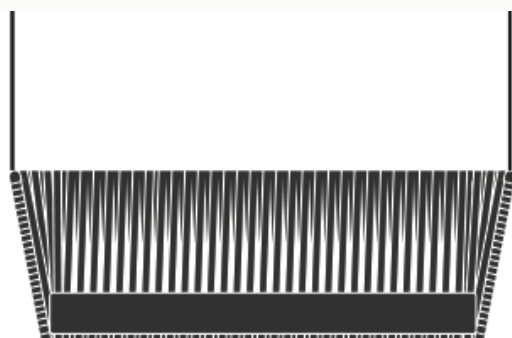
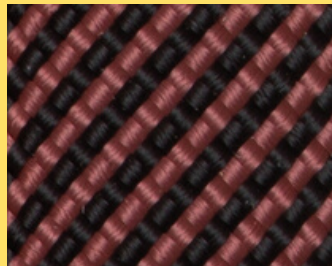

| 175 |

| 89 |

82
40
cm

Wheel Swing

Code - ADI666WH-SW

Application

Garden, Patio, Restaurant, Hotel, Beach, Resort and all the other leisure places.

Characteristic

UV-resistant, color-fast, waterproof, anti-mildew, comfortable, long-lasting, durable.

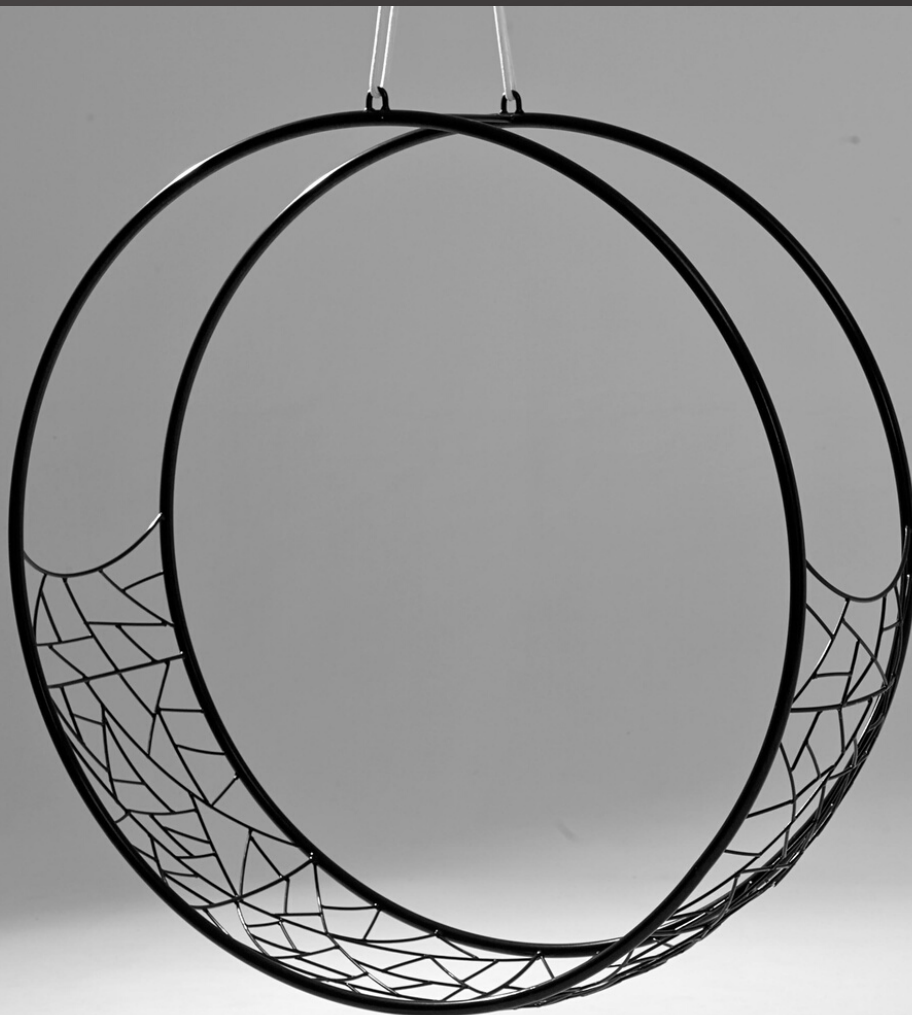

Material

Powder Coated Mild Steel

Packaging:

Pearl foam inside, Bubble wrap and Kraft paper or carton outside.



Color
Optional Customize

Size
195 cm length x 72 cm width x 128 cm deep

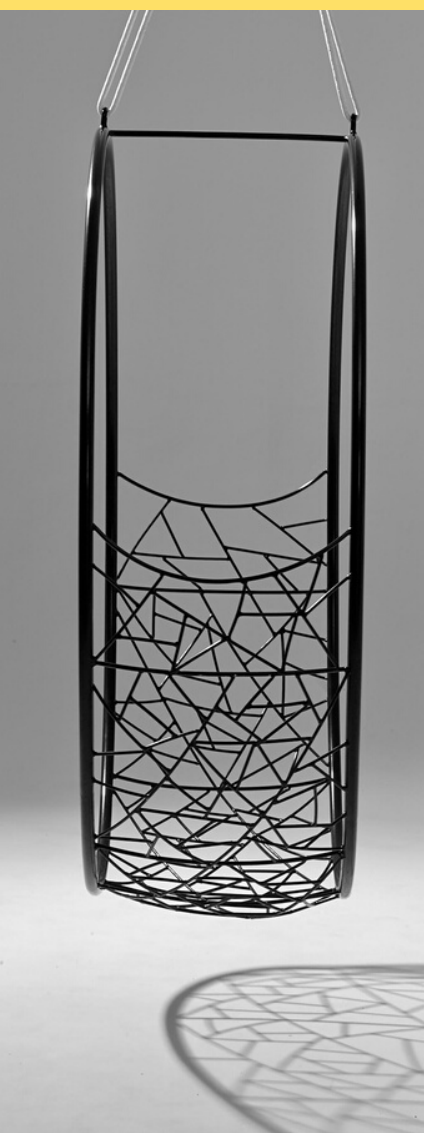

Basket Circle Swing

Code - ADI666BS-SW

Application

Garden, Patio, Restaurant, Hotel, Beach, Resort and all the other leisure places.

Characteristic

UV-resistant, color-fast, waterproof, anti-mildew, comfortable, long-lasting, durable.



Material

Powder Coated Mild Steel

Packaging:

Pearl foam inside, Bubble wrap and Kraft paper or carton outside.

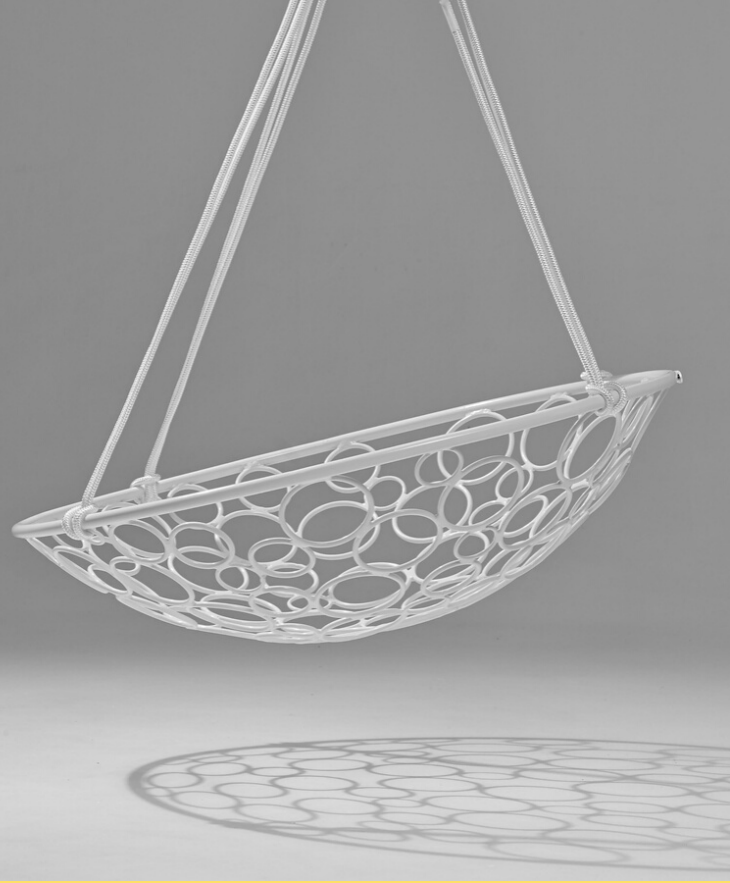

Color

Optional Customize

Size

1100 cm in diameter (100 cm length x 100 cm width) x 40 cm deep



Leaf Hang Swing

Code - ADI666LF-SW

Application

Garden, Patio, Restaurant, Hotel, Beach, Resort and all the other leisure places.

Characteristic

UV-resistant, color-fast, waterproof, anti-mildew, comfortable, long-lasting, durable.

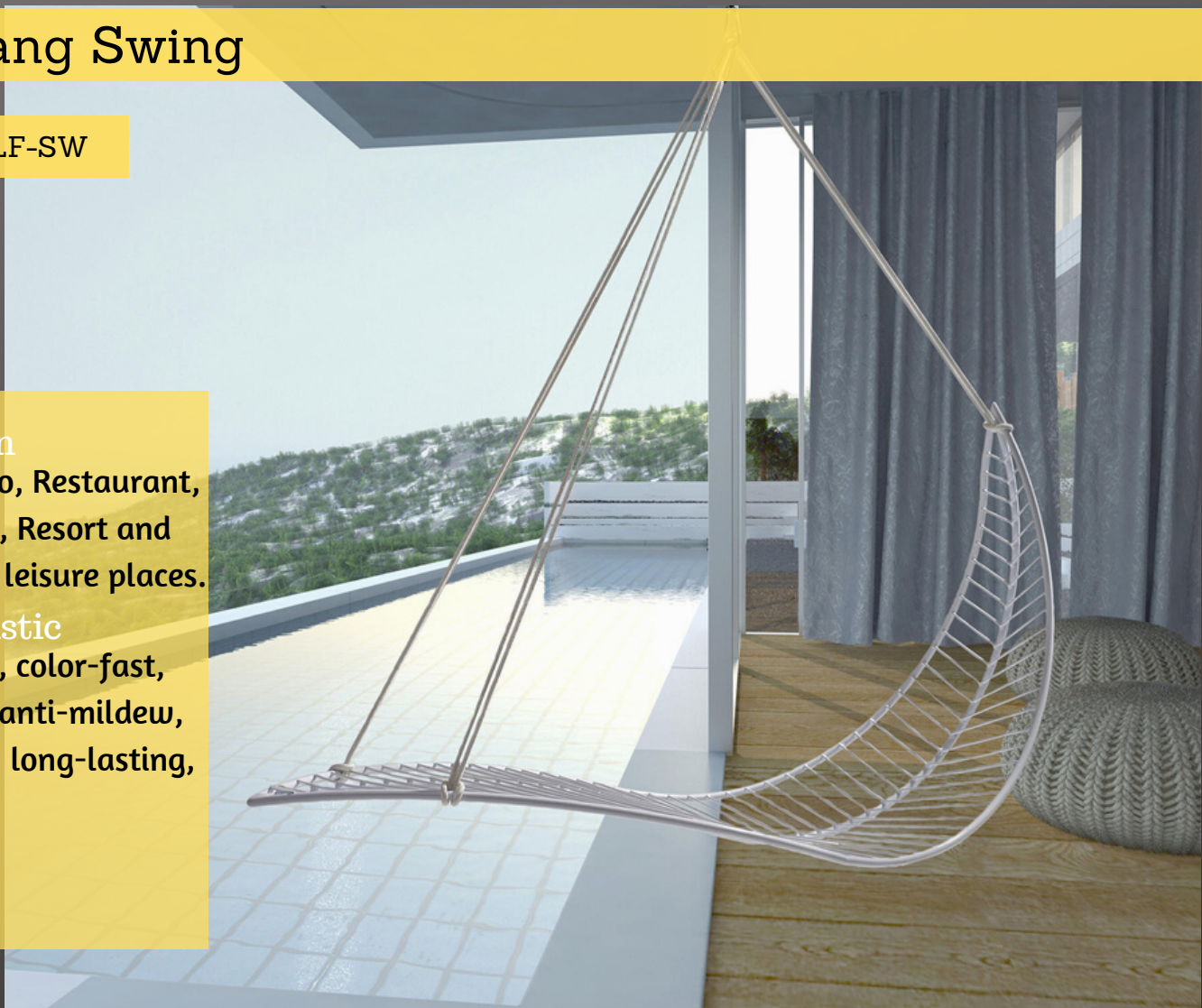

Material

Powder Coated Mild Steel

Packaging:

Pearl foam inside, Bubble wrap and Kraft paper or carton outside.

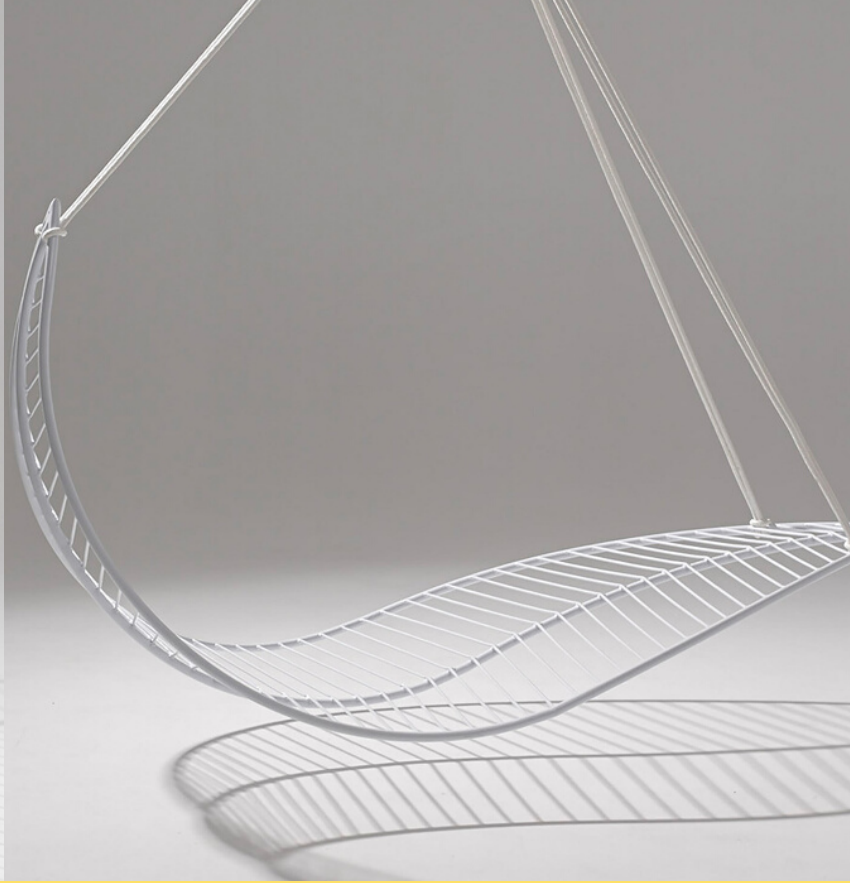

Color
Optional Customize

Size
205 cm length x 88 cm width x 78 cm deep



Leaf Hang Swing 2

Code - ADI666LF2-SW

Application

Garden, Patio, Restaurant, Hotel, Beach, Resort and all the other leisure places.

Characteristic

UV-resistant, color-fast, waterproof, anti-mildew, comfortable, long-lasting, durable.



Material

Powder Coated Mild Steel

Packaging:

Pearl foam inside, Bubble wrap and Kraft paper or carton outside.

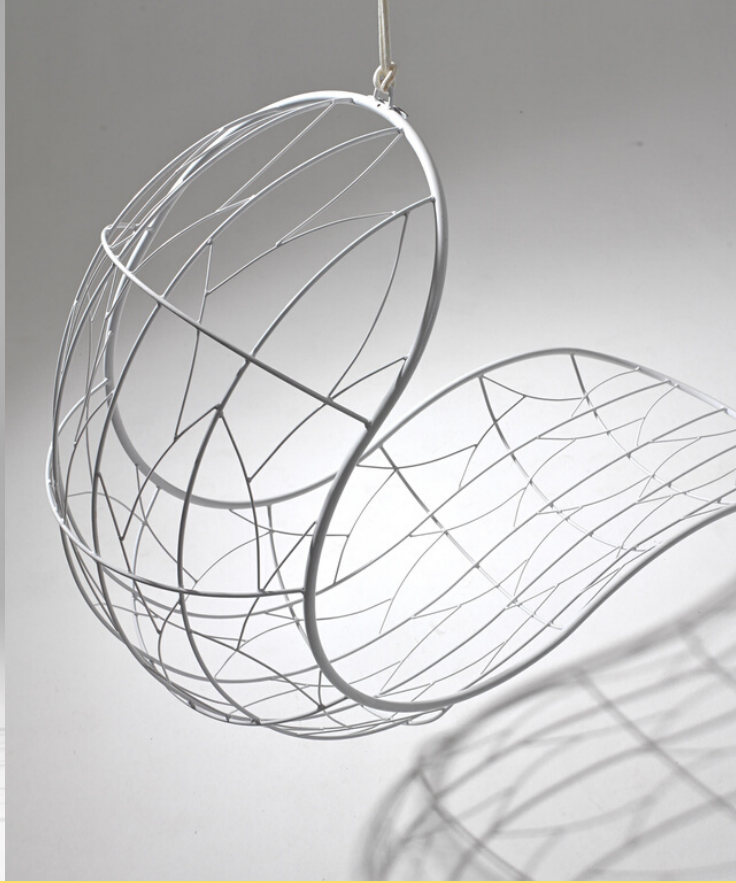

Color
Optional Customize

Size
195 cm length x 72 cm width x 128 cm deep



Melon Lounger Swing

Code - ADI666MLS-SW

Application

Garden, Patio, Restaurant, Hotel, Beach, Resort and all the other leisure places.

Characteristic

UV-resistant, color-fast, waterproof, anti-mildew, comfortable, long-lasting, durable.

Material

Powder Coated Mild Steel

Packaging:

Pearl foam inside, Bubble wrap and Kraft paper or carton outside.





Color

Optional Customize

Size

233 cm Length x 112 cm Width x 100 cm deep



Globo Ball Swing

Code - ADI666BS-SW

Application

Garden, Patio, Restaurant, Hotel, Beach, Resort and all the other leisure places.

Characteristic

UV-resistant, color-fast, waterproof, anti-mildew, comfortable, long-lasting, durable.



Material
Fir Wood

Packaging:
Pearl foam inside, Bubble wrap and Kraft paper or carton outside.



Color

Optional Customize

Size

Depth 21 cm X Height 69 cm



Wave Lounge Swing Chair

Code - ADI666WAS-SW

Application

Garden, Patio, Restaurant, Hotel, Beach, Resort and all the other leisure places.

Characteristic

UV-resistant, color-fast, waterproof, anti-mildew, comfortable, long-lasting, durable.

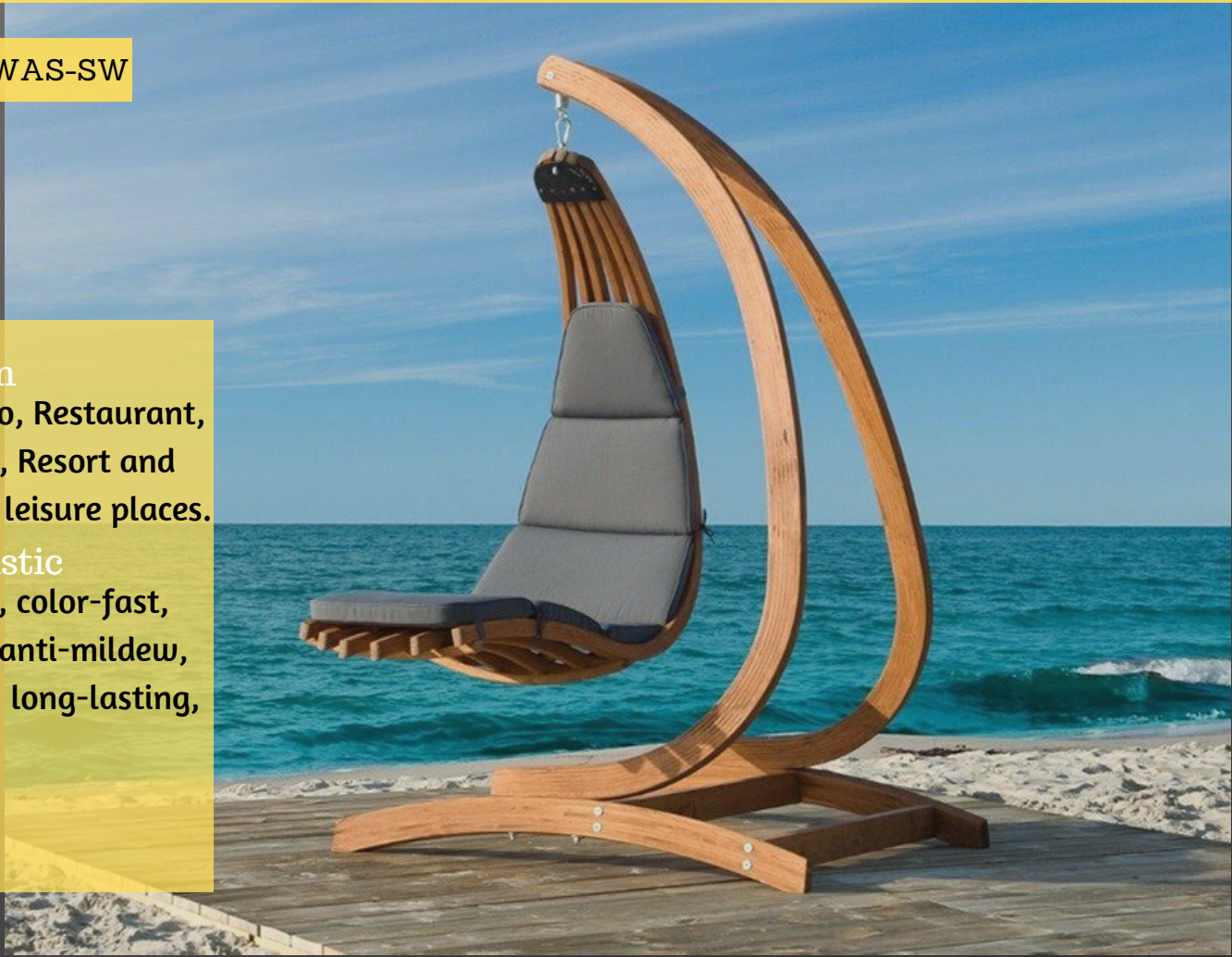

Material
Fir wood

Packaging:
Pearl foam inside, Bubble wrap and Kraft paper or carton outside.



Color
Optional Customize

Size
Width 64 cm X Depth 128 cm X Height 145 cm



Globo Royal Holiday Swing

Code - ADI666GRS-SW

Application

Garden, Patio, Restaurant, Hotel, Beach, Resort and all the other leisure places.

Characteristic

UV-resistant, color-fast, waterproof, anti-mildew, comfortable, long-lasting, durable.



Material
Fir wood

Packaging:
Pearl foam inside, Bubble wrap and Kraft paper or carton outside.



Color
Optional Customize

Size
Width/Length 176 cm X Depth 72 cm X Height 118 cm



Private Cloud Bed Swing

Code -ADI666PCSB-SW

Application

Garden, Patio, Restaurant, Hotel, Beach, Resort and all the other leisure places.

Characteristic

UV-resistant, color-fast, waterproof, anti-mildew, comfortable, long-lasting, durable.



Material

Oak wood

Packaging:

Pearl foam inside, Bubble wrap and Kraft paper or carton outside.



Color
Optional Customize

Size
Width: 180 cm X height 210 cm X length: 250 cm



Point Open Hood Swing

Code -ADI666PT-SW

Application

Garden, Patio, Restaurant, Hotel, Beach, Resort and all the other leisure places.

Characteristic

UV-resistant, color-fast, waterproof, anti-mildew, comfortable, long-lasting, durable.



Material

Aluminum or iron frame,
Synthetic fiber,
Rattan, Wicker

Packaging:

Pearl foam inside, Bubble wrap and Kraft paper or carton outside.



Color
Optional Customize

Size
Width: 150 cm X height 145 cm X Depth 110 cm



Maple leaf Swing

Code -ADI666MLFS-SW

Application

Garden, Patio, Restaurant, Hotel, Beach, Resort and all the other leisure places.

Characteristic

UV-resistant, color-fast, waterproof, anti-mildew, comfortable, long-lasting, durable.



Material

Aluminum or iron frame, Synthetic fiber, Rattan, Wicker

Packaging:

Pearl foam inside, Bubble wrap and Kraft paper or carton outside.



Color
Optional Customize

Size
length 150 cm X Width 78 cm X Depth 75 cm



Maple leaf Swing 2

Code -ADI666MLFS2-SW

Application

Garden, Patio, Restaurant, Hotel, Beach, Resort and all the other leisure places.

Characteristic

UV-resistant, color-fast, waterproof, anti-mildew, comfortable, long-lasting, durable.



Material

Aluminum or iron frame, Synthetic fiber, Rattan, Wicker

Packaging:

Pearl foam inside, Bubble wrap and Kraft paper or carton outside.



Color
Optional Customize

Size
length 155 cm X Width 82 cm X Depth 72 cm



Double Egg Afaf Swing

Code -ADI666AES-SW

Application

Garden, Patio, Restaurant, Hotel, Beach, Resort and all the other leisure places.

Characteristic

UV-resistant, color-fast, waterproof, anti-mildew, comfortable, long-lasting, durable.



Material

Aluminum or iron frame, Synthetic fiber, Rattan, Wicker

Packaging:

Pearl foam inside, Bubble wrap and Kraft paper or carton outside.



Color
Optional Customize

Size
Height 105 cm X Depth 75 cm Height 120cm



Round Egg Nest Swing

Code -ADI666REGG-SW

Application

Garden, Patio, Restaurant, Hotel, Beach, Resort and all the other leisure places.

Characteristic

UV-resistant, color-fast, waterproof, anti-mildew, comfortable, long-lasting, durable.



Material

Aluminum or iron frame,
Synthetic fiber,
Rattan, Wicker

Packaging:

Pearl foam inside, Bubble wrap and Kraft paper or carton outside.



Color
Optional Customize

Size
Height Ø 105 cm X Depth 75 cm



Bird Nest Swing

Code -ADI666BNS-SW

Application

Garden, Patio, Restaurant, Hotel, Beach, Resort and all the other leisure places.

Characteristic

UV-resistant, color-fast, waterproof, anti-mildew, comfortable, long-lasting, durable.

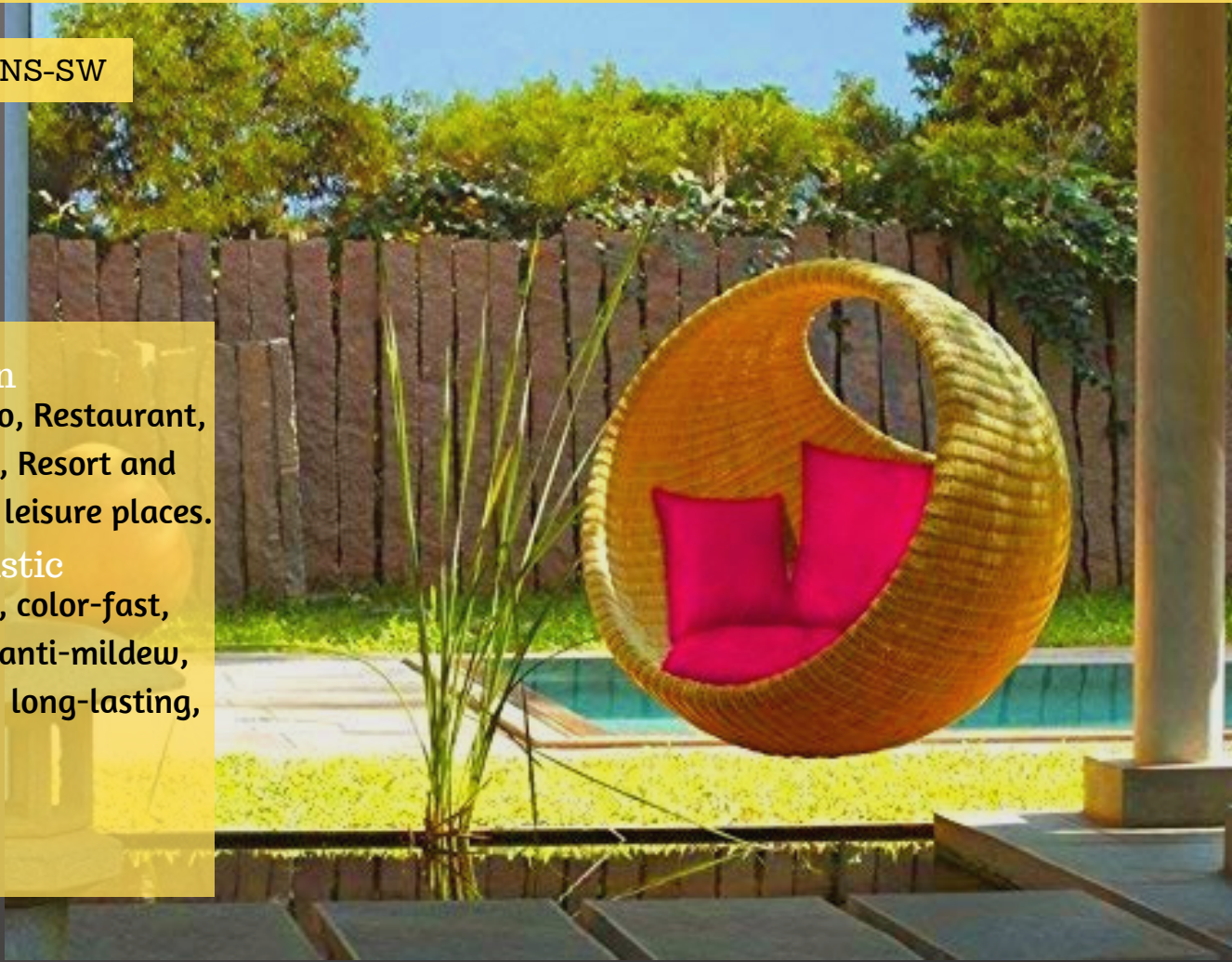

Material

Aluminum or iron frame, Synthetic fiber, Rattan, Wicker

Packaging:

Pearl foam inside, Bubble wrap and Kraft paper or carton outside.



Color
Optional Customize

Size
length 91 cm X width 46 cm X height 91 cm





CONTACT US

*34,35 Third Floor, Saket
Complex, opposite domino's
pizza, Radhanpur Road,
Mehsana, Gujarat 384001*

+91-7600203026

+91-7984595904

+91-9157390666

arvabildream@gmail.com

www.arvabilproduct.com